

SWD SERIES

MAIN FEATURES

Single-Head
Commercial
Embroidery
Machines

+ With intuitive 8" high definition true color touch screen system

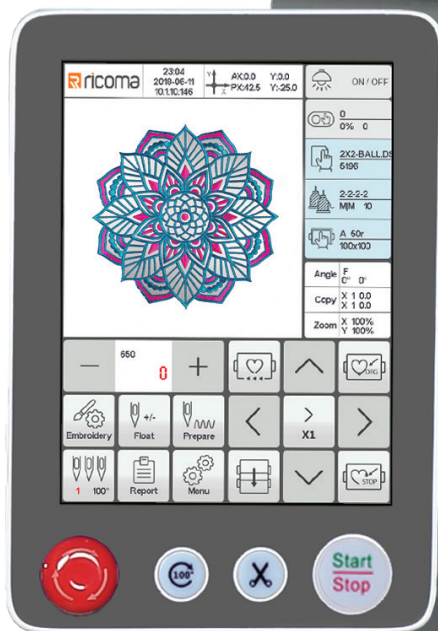

Single-head solutions

TECHNICAL SPECIFICATIONS

Models	SWD-1501-8S / SWD-1201-8S
Needles	15 / 12
Heads	1
Net weight	185 kilograms [408 lbs]
Gross weight	230 kilograms [507 lbs]
EMB. area	800mm x 500mm [32" x 20"]
Size	L: 850mm W: 965mm H: 952mm L: 33.5" W: 38" H: 37.5" Height with stand: 1,778mm [70"]

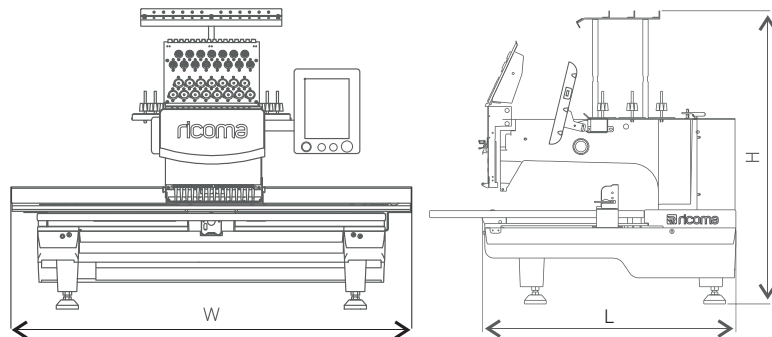

L: 850mm W: 965mm H: 952mm (L: 33.5" W: 38" H: 37.5")



AUTOMATIC COLOR CHANGE



THREAD BREAK DETECTION

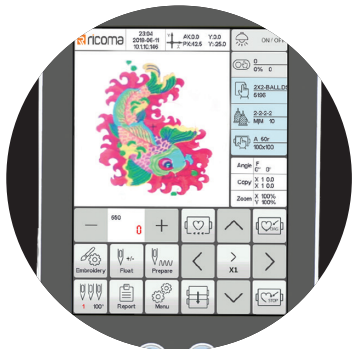

8" USER-FRIENDLY TOUCH PANEL



270° WIDE ANGLE CAP SYSTEM

Main features

GREAT FOR LARGER PROJECTS!

- Suitable for embroidery on flats, caps, finished garments and more!
- Perfect for larger embroidery projects
- High Definition True Color 8" LCD Touch Screen
- Maximum EMB. area: 800mm x 500mm (32" x 20")
- Net weight: 185 kgs (408 lbs)
- Gross weight: 230 kgs (507 lbs)
- Heavy duty steel stand with wheels to ensure both stability and mobility
- Thread break detection
- Maximum speed: 1000 SPM
- Memory capacity: 20 million stitches or 200 designs
- External 100° button and trimming button
- Automatic thread trimmer

Suited for all embroidery types

SWD-1201-8S

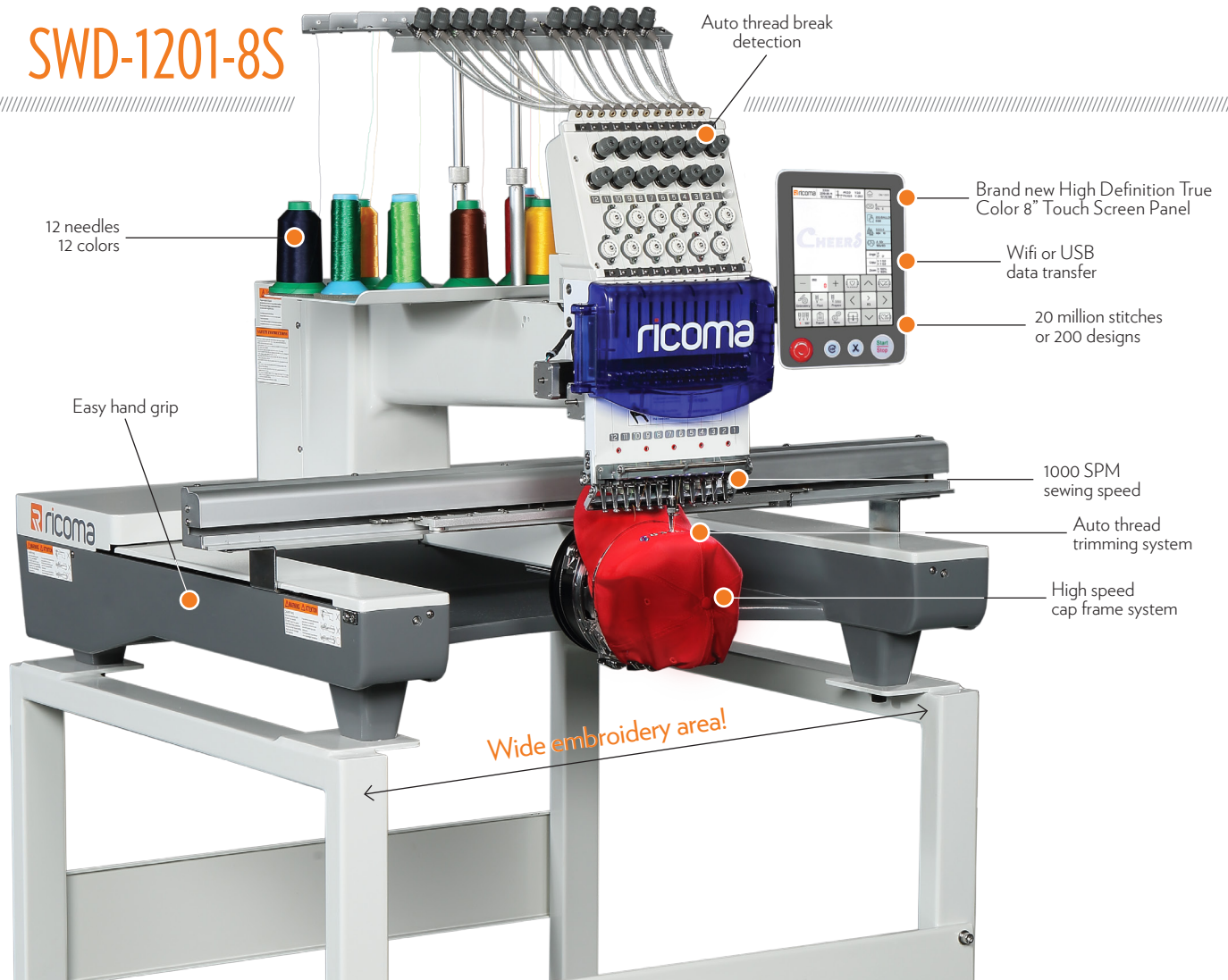

- Built-in leveler for easier machine installment
- Machine reads multiple design formats, such as DST, DSB and more
- 270° wide angle cap system
- Environmentally friendly packaging
- Networkable and Wi-Fi capable
- Automatic color change
- Servo motor 150W – lowest power consumption in the industry!
- Built-in universal power supply, 110V/60Hz and 200V/50Hz self-adaptable worldwide
- DC36V micro-step motor for X & Y axis driving to ensure low noise and less vibration
- Easily add appliqué, sequin, boring or cording

- Built-in 172° and 196° keys for easy machine maintenance
- Frame offset and frame outlining available for easy appliqué embroidery
- Adjustable control panel positioning for better visibility and comfort
- 2 recessed USB ports to protect USB flash drive
- One-step trace button directly on main screen
- Optional laser trace device available
- Emergency stop button
- Multiple hoop sizes for variety of embroidery needs
- Automatic memory retention
- Multiple languages: English, Chinese, Spanish, Portuguese, Turkish, Dutch, French, German, Russian, Vietnamese, Thai, Arabic and more

*Intelligent
technology*

*High speed with
high efficiency*

High Definition True Color 8" LCD

TECHNICAL SPECIFICATIONS

The intuitive High Definition True Color 8" LCD Touch Screen displays a clean interface with easy one-step commands for simple operation and a pleasant user experience.

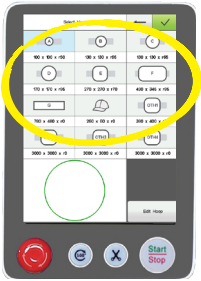

PRESET HOOPS

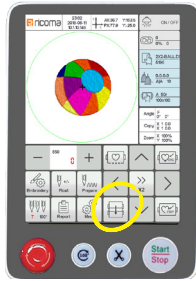

ONE-STEP APPLIQUE

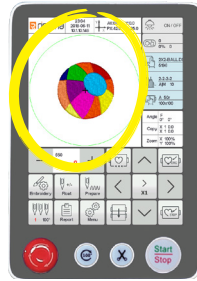

3D DESIGN VIEW

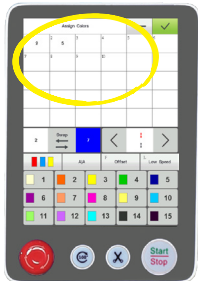

EASY COLOR SELECTION

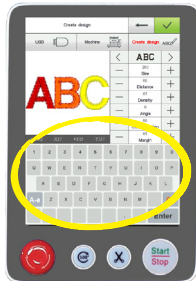

ON-BOARD LETTERING

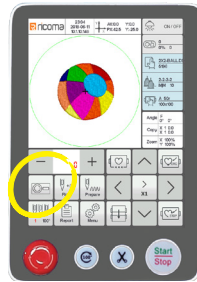

OPTIONAL CAMERA

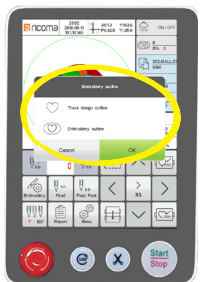

ONE-STEP TRACING

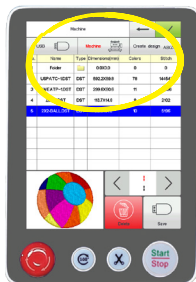

EASY DESIGN SELECTION



FILE FOLDER MANAGEMENT

Panel features

ENDLESS CAPABILITIES

- Easy to operate, user-friendly interface
- New ergonomic touch screen allows easy and comfortable operation by right hand thumb
- Preset hoop parameters, which are designed to avoid hitting hoop frames
- Automatic color change
- Optional camera positioning device
- Built-in factory mode, standardizing outgoing quality control process
- Built-in 172° and 196° keys for easy machine maintenance

User-friendly interface

*Newly re-designed
touch screen makes
embroidering
easier than ever!*

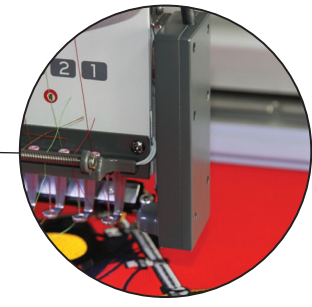

*Optional
camera*

- Frame offset/frame outlining available for easy appliqué embroidery
- Adjustable control panel positioning for better visibility and comfort
- One-step tracing button on home screen
- 3D design view for better visibility
- Machine parameters can be exported and imported for easy maintenance
- New needle path key optimizes embroidery production
- Built-in screenshots function

*Better
visibility*

- Built-in file management system
- Easily add appliqué, sequin, boring or cording
- External 100° button and trimming button
- Automatic thread trimmer
- Networkable and Wi-Fi capable
- Thread break detection
- Multiple languages: English, Chinese, Spanish, Portuguese, Turkish, Dutch, French, German, Russian, Vietnamese, Thai, Arabic and more
- Optional laser trace device available

*Ergonomic
design*

Hoops and cap attachments included

12 HOOPS OF DIFFERENT SIZES + 1 SASH FRAME

The SWD Series is perfect for embroidery on caps, bags, denim, finished garments and plenty more!

Each SWD comes equipped with 12 hoops of different sizes, a cap driver, 2 cap rings and a hoop station to fulfill all embroidery needs.

	(x2)	90mm round (9cm, 3.5")
	(x2)	120mm round (12cm, 4.7")
	(x2)	150mm round (15cm, 5.9")
	(x2)	200mm round (20cm, 7.9")
	(x2)	290x290mm square (29cm, 12")
	(x1)	420x420mm square (42cm, 16.5")
	(x1)	540x350mm oval (54 x 35cm, 22 x 14")
	(x1)	800x500mm sash frame (80 x 50 cm, 32" x 20")





Capable of
embroidering caps,
shirts, pants and
much more!



CAP ATTACHMENTS INCLUDED

Embroider any cap with ease with the machine's 270-degree wide angle cap system. Each SWD Series is suitable for cap embroidery and includes all the necessary cap attachments to get started.

Cap rings	(x2) Cap rings snap into hoop station to prepare machine for cap embroidery
Hoop station	(x1) Hoop station provides stability for fast and easy cap hooping
Cap driver	(x1) Cap driver snaps into embroidery machine's bracket holder for hoops



CAP RING

HOOP STATION

CAP DRIVER

Network Technology

FLEXIBLE PRODUCTION SYSTEM

Using advanced network technology, users can link together as many Ricoma SWD machines as desired to create an extremely flexible production system. Embroider the same design on all of your machines at the same time or embroider different designs on individual machines simultaneously.

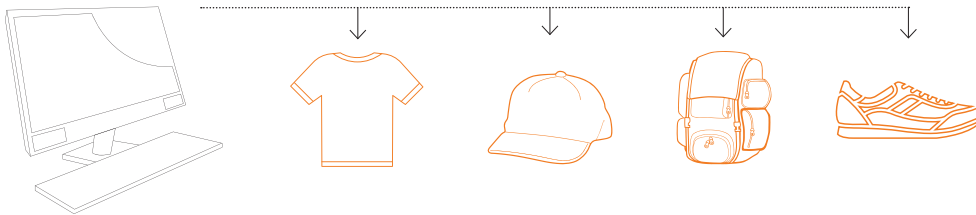

Included table and sash frame

FLAT TABLE W-3220

Each SWD Series embroidery machine includes a flat table with a sash frame designed for embroidering large and heavy items like towels, curtains, drapery and more!

Device dimensions: Extra large embroidery area 800 mm x 500mm (80x 50 cm, 32" x 20")



Expand your embroidery area with the 32" x 20" sash frame!

Startup package

EQUIPPED WITH ALL THE ATTACHMENTS TO GET STARTED RIGHT AWAY

Our SWD Series is ideal for commercial embroidery on caps, bags, denim, finished garments and plenty more. Equipped with all the necessary attachments to get started, the SWD is ideal for startups or established apparel businesses that want to add or expand their embroidery capabilities.



HEAVY DUTY STEEL STAND

Each SWD includes a heavy duty steel stand to support the machine. The stand's wheels assist with mobility and portability.



HIGH DEFINITION TRUE COLOR 8" LCD TOUCH SCREEN + PANEL

The modern touch screen interface and ergonomic panel allow for a user-friendly experience.

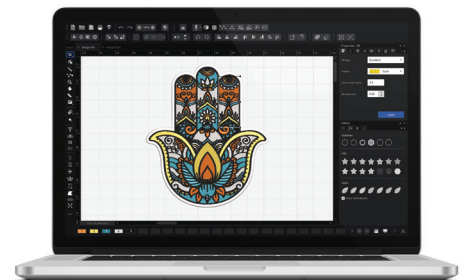

CHROMA SOFTWARE

Chroma, Ricoma's new proprietary software, is designed to allow both the novice and experienced digitizer to create even the most intricate designs with ease and speed.



AMANN STARTER KIT

Each starter kit comes with 20 spools of 100% polyester thread, two spools of metallic thread, a 144-piece box of pre-wound bobbins, two needles and four types of backing. *Items may vary.

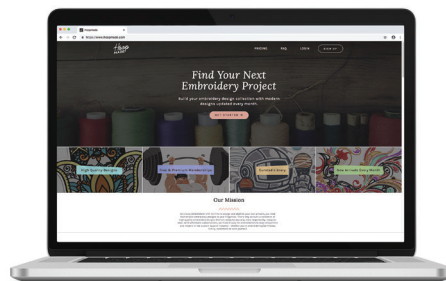

THREE-MONTH SUBSCRIPTION TO HOOPMADE

You will get the highest tier subscription, which includes access to premium designs in multiple sizes, cap designs, 3D puff designs, and patch designs.



TRAINING AND SUPPORT

Ricoma provides free hands-on training with the purchase of any embroidery machine. Our customer support is available 7 days a week and after hours.

*The above-mentioned items are included in the startup package only when purchased directly from our U.S. Headquarters – Ricoma International Corporation.

Optional add-ons

BROADEN YOUR POSSIBILITIES WITH THESE AFFORDABLE AND EASY-TO-USE ADD-ONS!

These attachments make hooping and adding embroidery effects a breeze. Embellish your designs with sequins, boring or cording; or use specialty hoops for all embroidery needs.

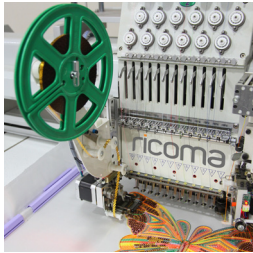

SEQUIN DEVICE

Attach the optional sequin device to your embroidery machine for a pop of sparkle to your embroidery and a quick and easy fill.

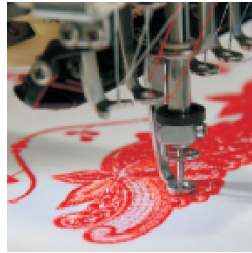

BORING DEVICE

This device punctures holes into embroidered designs and encloses the raw edges with stitches to create a beautiful effect within minutes.

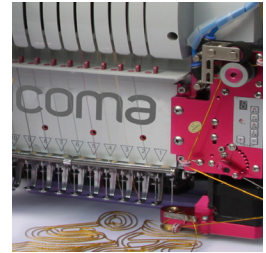

CORDING DEVICE

Easily create an embroidery effect with the cording device, which lays cord on fabric and attaches the cord with transparent zigzag stitches.

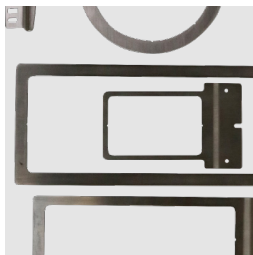

8-IN-1 DEVICE

Designed for non-hoopable, difficult items such as shirt pockets, socks, backs of caps, shirt sleeves, collar tips and more.



ROBOT FRAME

Embroider on difficult-to-embroider and unusually shaped items such as bags, pockets, shoes and purses with the robot frame.



BELT HOOP

With an 8-inch x 4-inch embroidery area, the belt hoop allows ample room for embroidery on belts and straps.



MIGHTY HOOP

With a wide variety of hoop sizes to choose from, these magnetic hoops make it quick and easy to hoop.



CAMERA POSITIONING DEVICE

Aids in correcting position and direction of designs in the case of improperly hooped items to ensure a precise embroidery outcome.



LASER DEVICE

With this easy-to-install tracing tool, there's no more hitting hoops — just simply watch the laser pointer trace the design in seconds.

Optional extended embroidery area

EXTENDED TABLE EW-4820

The extended table is the perfect aide for embroidery on oversized items such as drapery, blankets, banners, mattress borders, wedding dresses, quilt covers and much more.

Device dimensions Extra large embroidery area 1,200 mm x 500mm (120 x 50 cm, 48" x 20")



EXTENDED TABLE EW-4820

 ricoma



THINK BEYOND

www.ricoma.com



facebook.com/ricoma.us



youtube.com/ricomamiami



pinterest.com/ricomahq



instagram.com/ricomahq



twitter.com/ricomahq

Ricoma Headquarters in USA

Ricoma International Corporation

11555 NW 124 Street, Medley, FL 33178, USA

TEL: (305) 418-4421 | FAX: (305) 418-5036

Toll Free: 1-888-292-6282

Website: www.ricoma.com | Email: info@ricoma.com

Ricoma Factory in China

Ricoma (Shenzhen) Co., Ltd.

Baochangli Industrial Park, Jinlong Road 3,

Shenzhen, P.R. China (Post: 518118)

TEL: 400-900-2939 | 0755-25857772-8630 | FAX: +86-755-2585-7773

Website: www.ricoma.com.cn | Email: rcm@ricoma.cn